



Profesionálům dáváme to, co potřebují

BEST OF BAHCO 2023

autoopravárenství
&
průmyslová údržba

platné do 31.12.2023 nebo do odvolání

DÍLENSKÉ VOZÍKY



Protiskuzová pryžová pracovní plocha

Plně vysouvateľné zásuvky

Centrální zamykání s trubkovým klíčem

Vysoká nosnost

Ochrana rohů

Ø125 x 36 mm

barva:
oranžová RAL2009

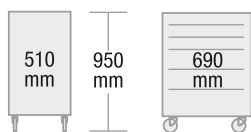

Řada 1472K Díleňský vozík, prázdný



1472K5 5 zásuvek

Vnitřní rozměry zásuvek:

(1x) 543 x 445 x 53 mm
(2x) 543 x 445 x 118 mm
(2x) 543 x 445 x 184 mm

14.569 Kč



1472K6 6 zásuvek

Vnitřní rozměry zásuvek:

(3x) 543 x 445 x 53 mm
(2x) 543 x 445 x 118 mm
(1x) 543 x 445 x 249 mm

15.018 Kč



1472K7 7 zásuvek

Vnitřní rozměry zásuvek:

(5x) 543 x 445 x 53 mm
(1x) 543 x 445 x 118 mm
(1x) 543 x 445 x 249 mm



1472K8 8 zásuvek

Vnitřní rozměry zásuvek:

(6x) 543 x 445 x 53 mm
(1x) 543 x 445 x 118 mm
(1x) 543 x 445 x 184 mm

16.354 Kč

DÍLENSKÉ VOZÍKY

1472K6BKFF7SD

Díleňský vozík se 6 zásuvkami
vybaven 214 kusy nářadí

■ 3 moduly nářadí 543 x 445 mm

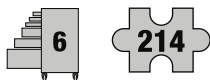

Barva
Černá ■ RAL 9005

FF1A81

Šroubováky a klíče



B191.040.100	⌀ 4.0 x 0.8 x 100	
B190.055.125	⌀ 5.5 x 1.2 x 125	
B190.065.150	⌀ 6.5 x 1 x 150	
B192.000.075	PH0 x 75	
B192.001.100	PH1 x 100	
B192.002.125	PH2 x 125	
111M	6-7-8-9-10-11-12-13-14-15-16-17-19-21-22-24 mm	
BE-9770-B	1.5-2-2.5-3-4-5-6-8-10 mm	

FF1A82

Úderové nářadí a kleště



3734S/6-T	⌀ 2-3-4-5-6-8 mm; l: 150 mm	
479-16	450 g	
3625W-35	⌀ 35 mm	
MTG-3-16	3 m; 16 mm	
KB18-01	18 x 161 mm	
KSBG18-10 DISPEN	18 mm, x10 ⌀ 125 x 36 mm	

2101G180	l: 180 mm	
2678G-180	2.0; 1.4; l: 180 mm	
2470G-200	l: 200 mm	
2530	l: 350 mm	
8224	l: 250 mm	

fit & go
Moduly jsou k dispozici i jednotlivě

FF1A179

Nástrční klíče a příslušenství



2058-BR	1/4", 8 mm	
59/S100B-T	1/4": 4.5-5.5; PH1(x2)-PH2(x9)-PH3-PH2G(x5); PZ1(x2)-PZ2(x9)-PZ3; T10(x3)-T15(x5)-T20(x15)-T25(x8)-T27-T30(x15)-T40(x3)-TR10-TR15-TR20-TR25-TR30; HEX3-HEX4(x3)-HEX5-HEX6(x3)-HEX8; R1-R2	
6950SL	1/4" ⌀ 1/4" l: 120 mm	
8150SL	1/2" ⌀ 1/2" l: 265 mm	
6700SM	1/4" ⌀ 4-4.5-5-5.5-6-7-8-9-10-11-12-13-14 mm	
A6800DM	1/4" ⌀ 7-8-9-10-11-13 mm	
6956	1/4" ⌀ 1/4" l: 150 mm	
6961	1/4" ⌀ 1/4" l: 100 mm	
6966	1/4" ⌀ 1/4" l: 35 mm	
7800SM	1/2" ⌀ 10-11-12-13-14-15-16-17-18-19-20-21-22-24-27-30-34 mm	
7805DM	1/2" ⌀ 10-13-17-18-19-16-21-22 mm	
7805SM	1/2" ⌀ 16-21 mm	
8160-1/2	1/2" ⌀ 1/2" l: 125 mm	
8162-1/2	1/2" ⌀ 1/2" l: 250 mm	
8166-1/2	1/2" ⌀ 1/2" l: 172 mm	
8156-1/2	1/2" ⌀ 1/2" l: 257 mm	
7106S0080	1/2" ⌀ 5/16"	
6973	1/4" ⌀ 1/4"	
70S	5/16" ⌀ T45-T50-T55	



Díleňský vozík Řada 1472K



- Vysoká stabilita díky dvoustěnnému vyztuženému rámu
- Zvýšený okraj zabraňuje pádu nářadí a jiných předmětů
- Široký sortiment příslušenství

510 mm	950 mm	690 mm
--------	--------	--------

Všechny ceny jsou uvedené bez DPH.

DÍLENSKÉ VOZÍKY S NÁŘADÍM

1472K6/S1

Díleňský vozík se 6 zásuvkami
se 177 kusy nářadí

■ 3/3 moduly nářadí 543 x 445 mm

FF1A04

Klíče

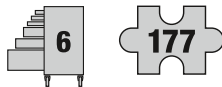

S4RM	8-11-12-15-16-19 mm		
111M	6-7-8-9-10-11-12-13-14-15-16-17-18-19-21-22-24-27-32 mm		
6M	6-7-8-9-10-11-12-13-14-15-17-19 mm		
9071C	27 mm; 208 mm / 8"		

49.209 Kč



FF1A05

Nástrčné klíče s příslušenstvím



● 1/4" + 1/2"

BE-9678	1.5-2-2.5-3-4-5-6-8-10 mm	
SBS60	1/4" 4-4.5-5-5.5-6-7-8-9-10-11-12-13-14 mm	
SBS61	1/4" - 145 mm	
SBS63-2	1/4" - 50 mm	
SBS63-4	1/4" - 100 mm	
SBS63-6	1/4" - 150 mm	
SBS64	1/4" 1/4" - 125 mm	
SBS65	1/4" 1/4" - 32.5 mm	
SBS67	1/4" - 153 mm	
SBS69	1/4" 3/8" - 25 mm	
SBS80	1/4" 10-11-12-13-14-15-16-17-18-19-21-22-24-27-30-32 mm	
SBS88	1/2" 3/8" - 37 mm	

59S/31-1	1/4": PH1-PH2-PH3-PH2G; T25-T15-T20-T10-T27-T30; H3-H4-H5-H6; PZ1-PZ2-PZ3; 0.8x3.5-0.8x4.5-0.5x3.0; KM653-QR	
6956	1/4" 1/4" - 150 mm	
6972H	1/4" 1/4" - 26 mm	
7809M	1/2" - 5-6-7-8-10-12-14-17-19 mm	
7809TORX	1/2" - T20-T25-T27-T30-T40-T45-T50-T55-T60	
808050	1/4" 125 mm	
8150SL	1/2" 1/2" - 265 mm	
8154-1/2	1/2" 283 mm	
8160-W	1/2" 1/2" - 125 mm	
8162-1/2	1/2" 1/2" - 250 mm	
8166-1/2	1/2" 1/2" - 72 mm	

FF1A06

Šroubováky a kleště



BE-8020L	0.5 x 3.0 x 75	
BE-8040	0.8 x 4.0 x 100	
BE-8150	1.0 x 5.5 x 100	
BE-8255	1.2 x 6.5 x 150	
BE-8256	1.6 x 8.0 x 150	
BE-8350	1.0 x 5.5 x 25	
BE-8601	PH1 x 25	
BE-8610	PH1 x 75	
BE-8620	PH2 x 100	
BE-8910	T10 x 75	
BE-8915	T15 x 100	
BE-8920	T20 x 100	
BE-8925	T25 x 125	
BE-8927	T27 x 125	
BE-8930	T30 x 150	

MTB-3-16	3 m; 16 mm	
2101G-160IP	160 mm	
2427 G-200 IP	200 mm	
2535L	20 mm	
2620 G-160IP	1.8; 2.0; 160 mm	
2951-180	2.0 - 180 mm	
5515T-52	30 mm; 180-690 mm	
8224 IP	250 mm	

FF1A07

Pilníky, úderové nářadí,
pilka na kov



3734N	150 mm - 3-5-6 mm	
3735N-4-120	120 mm - 4 mm	
3740-175	175 mm - 21 mm	
SQZ150003	170 mm	
1-100-08-2-2	200 mm	
1-210-08-2-2	200 mm	
1-230-08-2-2	200 mm	
2744	190 mm	

3625W-35	35 mm; 100x300 mm	
3745-150	150 mm; 6 mm; 17x11 mm	
481-400	400 g; 112x300x25 mm	
782-U	290 mm	
317	432 mm / 17"	

Fit
&
go

Moduly jsou
k dispozici
i jednotlivě.

1472K7/S1

Dílenský vozík se 7 zásuvkami se 300 kusy nářadí

■ 3/3 moduly nářadí 543 x 445 mm



Moduly jsou k dispozici i jednotlivě.

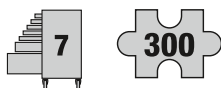

80.138 Kč



FF1A08

Nástrčné klíče s příslušenstvím

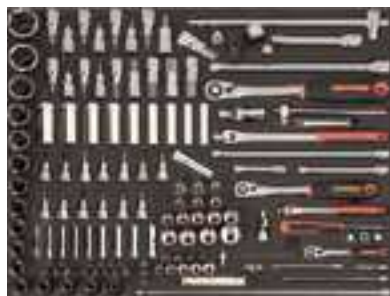

1/4"
3/8"
1/2"

A6800DM	1/4"	5.5-6-7-8-9-10-11-12-13 mm	
A7402DM	1/4"	10-11-12-13-14-15-16-17-18-19 mm	
1544		76 mm - 0.03-1.00 mm	
6700SM	1/4"	5.5-6-7-8-9-10-11-12-13 mm	
6709M	1/4"	3-4-5-6-8 mm	
6709PH	1/4"	PH1-PH2-PH3	
6709TORX	1/4"	T8-T9-T10-T15-T20-T25-T27-T30-T40	
6950SL	1/4"	1/4"	120 mm
6954	1/4"	1/4"	115 mm
6956	1/4"	1/4"	150 mm
6958	1/4"		153 mm
6960	1/4"		50 mm
6961	1/4"		101 mm
6962	1/4"		152 mm
6962L	1/4"		335 mm
6966	1/4"	1/4"	35 mm
6972H	1/4"	1/4"	26 mm
7400SM	1/4"	6-7-8-9-10-11-12-13-14-15-16-17-18-19-22 mm	
7407H	1/4"	3/8"	26 mm
7409M	3/8"	3-4-5-6-7-8-10 mm	
7409TORX	3/8"	T25-T27-T30-T40-T45-T50	
7750SL	3/8"	3/8"	205 mm
7754	3/8"	3/8"	160 mm
7758	3/8"		250 mm
7760	3/8"		75 mm
7761	3/8"		127 mm
7762	3/8"		252 mm
7764	3/8"	1/4"	24,7 mm
7765	1/4"	3/8"	25 mm
7766	3/8"	3/8"	51,5 mm
7800SM	1/2"	10-11-12-13-14-15-16-17-18-19-21-22-24-27-30-32 mm	
7807H	1/4"	1/2"	38 mm
7809M	1/2"	5-6-7-8-10-12-14-17-19 mm	
7809TORX	1/2"	T20-T25-T27-T30-T40-T45-T50-T55-T60	
8150SL	1/2"	1/2"	265 mm
8154-1/2	1/2"	1/2"	283 mm
8160-1/2	1/2"	1/2"	125 mm
8162-1/2	1/2"	1/2"	250 mm
8164-1/2	3/8"	1/2"	33 mm
8165-1/2	1/2"	3/8"	37 mm
8166-1/2	1/2"	1/2"	72 mm
8964	1/2"	3/4"	45 mm

FF1A09

Klíče



111M	6-7-8-9-10-11-12-13-14-15-16-17-18-19-21-22-24-27-30-32 mm	
1320RM	8-9-10-11-12-13 mm	
6M	6-7-8-9-10-11-12-13-14-15-16-17-18-19-20-22-24-27-30-32 mm	
9071C	27 mm; 208 mm / 8"	

FF1A10

Šroubováky a měřicí nářadí



BE-8020L	0.5 x 3.0 x 75	
BE-8030	0.6 x 3.5 x 75	
BE-8155	1.2 x 6.5 x 125	
BE-8260	1.6 x 8.0 x 175	
BE-8350	1.0 x 5.5 x 25	
BE-8601	PH1 x 25	
BE-8602	PH2 x 25	
BE-8610	PH1 x 75	
BE-8620	PH2 x 100	
BE-8630	PH3 x 150	
BE-8910	110 x 75	
BE-8915	115 x 100	
BE-8920	120 x 100	
BE-8925	125 x 125	
BE-8927	127 x 125	
BE-8930	130 x 150	
BE-8940	140 x 150	
BE-9770	1.5-2-2.5-3-4-5-6-8-10 mm	
MTB-3-16	3 m; 16 mm	
1150-112H/P	235 x 75 x 9	
1177-SCRIBE	70°; 230 mm	
2820EF2	200 mm	
5515T-52	30 mm; 180-690 mm	
59S/31-1	1/4"; PH1-PH2-PH3-PH2G; T25-T15-T20-T10-T27-T30; H3-H4-H5-H6; PZ1-PZ2-PZ3; 0.8x5.5-0.6x4.5-0.5x3.0; KM653-DR	
808050S	1/4"; 68 mm	
2047-0.8-4	100 mm	
2047PR-1-2	PH1-2 x 100 mm	

FF1A12

Řezací a úderové nářadí



FS-8	165 mm	
1-100-06-1-2	150 mm	
1-100-06-2-2	150 mm	
1-160-06-1-2	150 mm	
1-210-06-1-2	150 mm	
1-230-06-1-2	150 mm	
2509	525 mm	
2535F2	10 mm; 535 mm	
3625W-35	35 mm; 100x300 mm	
3734	150 mm - 3-5-8 mm	
3735-4-120	120 mm - 4 mm	
3740-150	150 mm - 18 mm	
3745-150	150 mm - 6 mm	
481-300	300 g; 105x300x23 mm	
481-500	500 g; 118x300x27 mm	
8158-1/2	1/2"; 390 mm	
319	300 mm / 11"	

FF1A11

Kleště



2101GC-125IP	125 mm	
2101GC-160IP	160 mm	
21HDGC-200IP	200 mm	
2427 GC-200IP	200 mm	
2430 GC-200 IP	200 mm	
2628 GC-160IP	2.0; 1.8; 160 mm	
2928	160-200-250 mm	
2951-250	3.0; 250 mm	
2952-165	165 mm	
8224CIP	250 mm	

VYBAVENÍ DÍLNY

1475KXL6C
Dílenský vozík XL

 Dílenský vozík XL
se 6 zásuvkami
a boční skříňkou

26.614 Kč

 Velká nosnost: **600 kg**
 Vnitřní rozměry zásuvek:
 (3x) 543 x 445 x 53 mm
 (2x) 543 x 445 x 118 mm
 (1x) 543 x 445 x 249 mm

BLE301
Pojízdné montážní lehátko

990 x 320 mm

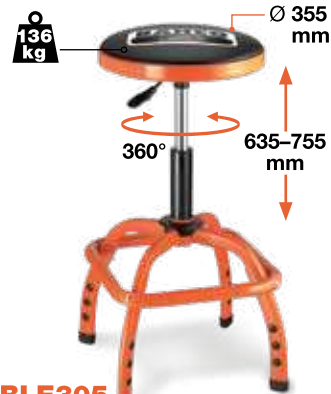
BLE300
Dílenská židle se
zásuvkami

BLE305
Dílenská židle výškově
nastavitelná
5750
Kryt sedadla

 ■ Nylon, odolný
vůči kapalinám,
snadno omyvatelný

327 Kč

1390 mm

B147.001.400
Ohebný magnetický
podavač

1 kg

531 Kč

Ø 10 mm

BMD150
Magetická
miska

Ø 150 mm

224 Kč

PVC

HYDRAULICKÉ NÁŘADÍ A ZVEDÁKY

Zvedák

■ Dvojitý píst umožňuje o 50 % rychlejší zdvih



Video návody a manuály

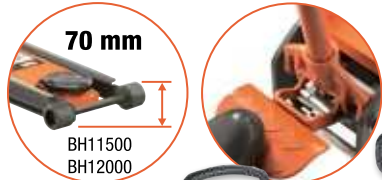

70 mm

BH11500
BH12000



1,5 T

2 T

3 T



70 – 610 mm



70 – 490 mm



90 – 552 mm

BAHCO	T	▲ mm	▲ mm	← mm →	kg	Kč
BH11500	1,5	70	610	945	51	
BH12000	2	70	490	790	45	
BH13000	3	90	552	820	51	

Hliníkový zvedák

■ Velmi lehký a ideální pro mobilní použití

■ Dvojitý píst pro rychlé zvedání

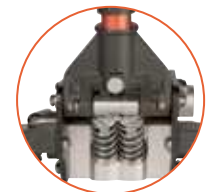

BH1A1500A včetně přepravní tašky



85 – 415 mm

Pohodlná rukojeť



12,8 kg

BAHCO	T	▲ mm	▲ mm	← mm →	kg	Kč
BH1A1500A	1,5	85	415	542	12,8	

BH1CB1000

Podpěrný stavitelný nosník



1 T

— Ø 30 mm

582 – 920 mm

■ BH11500,
BH1200,
BH13000

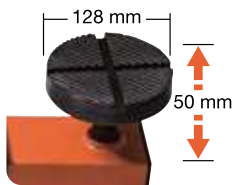

128 mm

50 mm

ZVEDÁKY A PODPĚRY

Podpěra

BH33000 3 t

- 1 pár
- S bezpečnostním kolíkem



BH36000 6 t

- 1 pár
- S bezpečnostním kolíkem



2.524 Kč

BH4- Hydraulický přenosný zvedák

- S bezpečnostním ventilem
- Dvojitě svařované pouzdro pro vysokou nosnost a těsnost

- Další nastavení výšky pomocí šroubovaného sedla



BH4S- Hydraulický přenosný zvedák

- S bezpečnostním ventilem
- Dvojitě svařované pouzdro pro vysokou nosnost a těsnost
- Další nastavení výšky pomocí šroubovaného sedla



BAHCO	T	mm	mm	kg	Kč
BH42	2	174	369	3,8	1.637
BH45	5	212	467	5,1	2.020
BH410	10	220	483	7,4	2.557
BH415 *	15	231	498	9,7	3.269
BH420 *	20	241	521	13,2	4.249
BH430 *	30	244	492	16,3	5.617

BAHCO	T	mm	mm	kg	Kč
BH4S2	2	168	316	2,0	712
BH4S4	4	188	363	2,8	
BH4S6	6	207	402	3,7	953
BH4S8	8	222	447	4,8	
BH4S12 *	12	227	457	6,0	1.637
BH4S20 *	20	235	445	8,6	2.436

*s rukojetí

BH8AC2-500
Otočný stojan na motor do 500 kg

- Pro snadnou údržbu motoru
- Snadné otáčení pomocí převodu pomocí kliky
- Skládací klika



Nastavitelná montážní ramena



500 kg



10.556 Kč



Odnímatelná olejová vana



Unikátní převodový poměr 70:1

BH1CD680
Manipulační vozík

- Určeno pro snadnou manipulaci s osobními vozidly nebo lehkými dodávkami
- Rukojeť potažená PVC



680 kg

4.610 Kč

Nožní pedál pro rychlé zvedání



otevřeno



zavřeno



BS15
Sada na stlačení pružin Mc Pherson

- max. síla stlačení: 1 T
- max. rozpon čelistí: 300 mm
- vhodné pro rovné i kónické pružiny
- dodáváno v odolném plastovém kufru

9.778 Kč



LISY A JEŘÁBY

Dílečné lisy

- Vrátek s otočnou pákou ulehčuje manipulaci s lisem
- Robustní a stabilní rám a podstavec

8

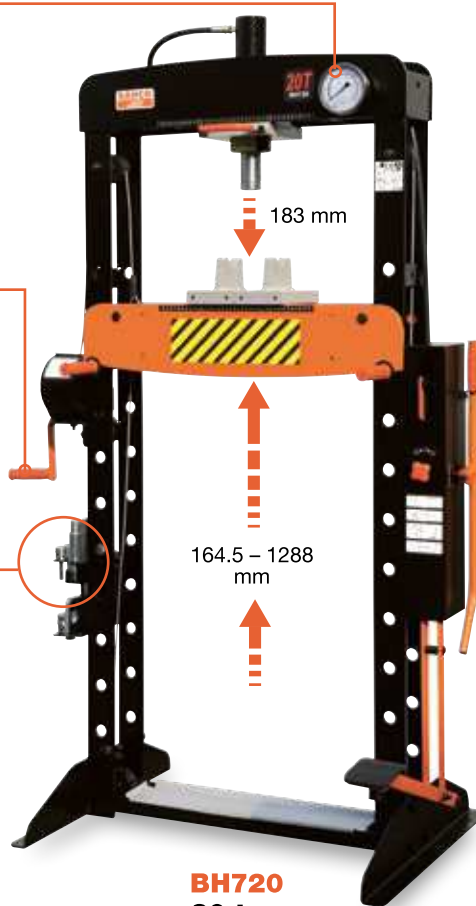
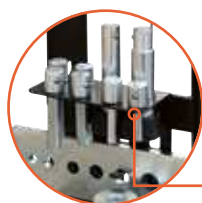

BH720
20 tun

6

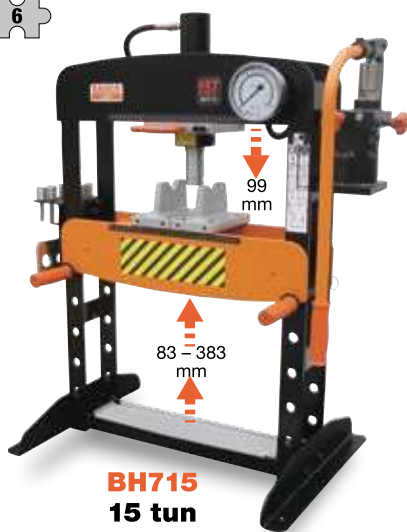

BH715
15 tun



Video návody
a manuály

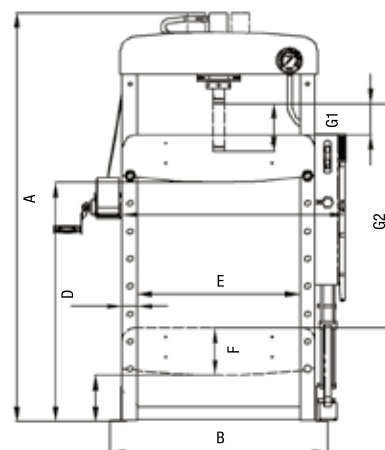

BAHCO	↓	A mm	B mm	C mm	D mm	E mm	F mm	G1 mm	G2 mm	kg	Kč
BH715	15 t	970	695	500	383	495	83	99	399	80	27.802
BH720	20 t	1885	880	650	1288	645	164.5	43	1143	151	41.479

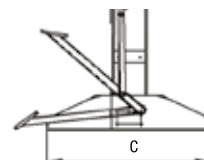



BOD8903A
Vzduchové olejové čerpadlo



9-litrová komora pro okamžitou vizuální kontrolu stavu oleje

90 L

15.461 Kč

- Použitý olej odčerpává buď gravitačním nebo sacím mechanismem z motorů, převodovek a diferenciálů všech různých typů aut
- Maximální vypouštěcí tlak: 1 Bar/14,5 PSI
- Sací tlak: 7-8 Bar/100-115 PSI

Skládací jeřáb

- Bezpečnostní systém Dead-man
- Bezpečnostní ventil proti přetížení

- Dvojitý píst umožňuje o 50 % rychlejší zvednutí
- CE-certifikováno dle 2006/42/EC a BS EN1494

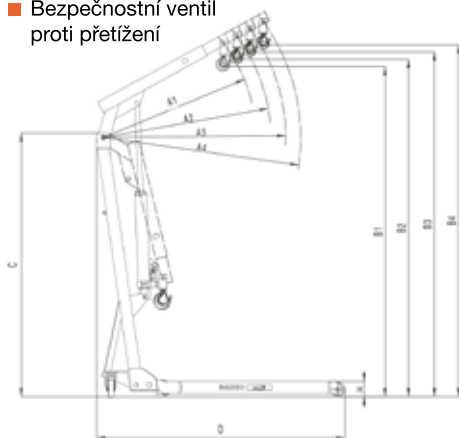

Video návody a manuály



BAHCO	≡	A1 kg	A2 kg	A3 kg	A4 kg	B4 mm	C mm	D mm	H mm	kg	Kč
BH6FC1000	1 t	1000	750	500	250	2175	1578	1480	88	85	16.354
BH6FC2000	2 t	2000	1500	1000	500	2640	1880	1845	130	170	28.218



BH6AC1-680A
Manipulační rameno na motor

- Vhodné pro BH6FC1000 a BH6FC2000

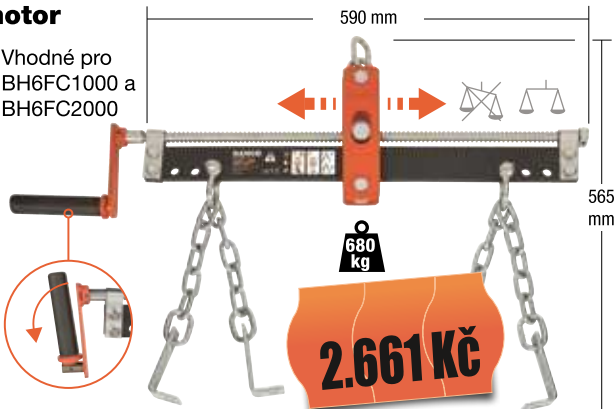

2.661 Kč

RUČNÍ NÁŘADÍ

BE254A

Kleště na hadicové spony

- Pro bezpečnou a profesionální montáž a demontáž spon
- Průměr hadice Ø 18 – 53 mm

Flexibilní hlava pro přístup k těžko dostupným sponám

Včetně aretační a zamykací funkce

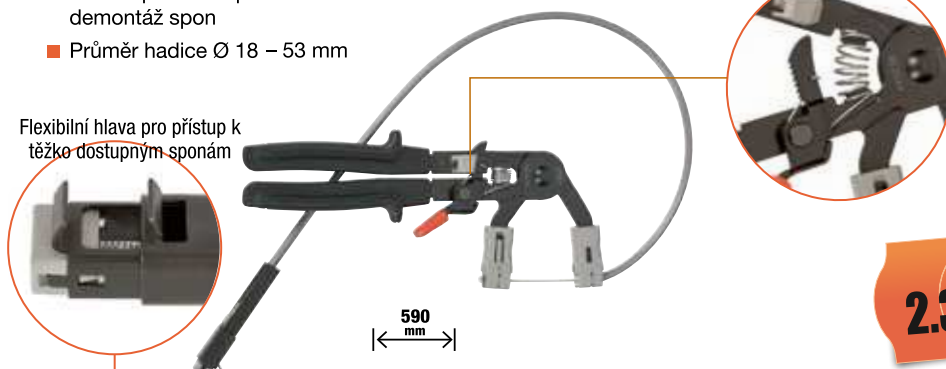

2.316 Kč

Sady šroubováků s T-rukojetí

903T-1



903T-2



HD

Krátká 90° čepel na utahování / povolování s vysokým točivým momentem v místech s omezenou výškou.

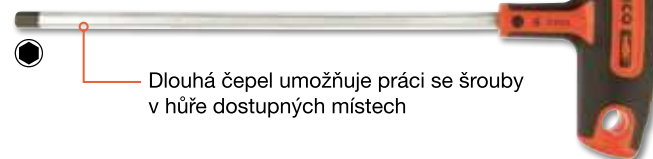

Dlouhá čepel umožňuje práci se šrouby v hůře dostupných místech

HD

Krátká 90° čepel



2-složková rukojeť

BAHCO			Kč
903T-1	●	Šestihran	3, 4, 5, 6, 8, 10 mm 1.637
903T-2	★	TORX®	T10, T15, T20, T25, T30, T40 1.336

Sada očkoplochých klíčů

111M/14T

14

- ISO 691 / ISO 7738 / ISO 3318 / ISO 1711-1 / DIN 3113

- metrické rozměry

- 6 8 9 10 13 14 15 17 19 22 24 27 30 32 mm



3.241 Kč

Kombinované ráčnové klíče

ISO 1711-1 / DIN 3113



■ Přepínatelné

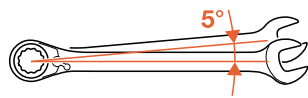
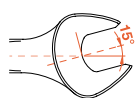

- Vysoce výkonná legovaná ocel
- Pochromovaná a mikrokrovná vysoce kvalitní povrchová úprava

BAHCO	mm	mm	g	Kč
1RM-6	6	128	27	268
1RM-7	7	140	35	268
1RM-8	8	140	38	274
1RM-9	9	150	48	290
1RM-10	10	159	59	307
1RM-11	11	165	67	307
1RM-12	12	172	82	323
1RM-13	13	178	95	323
1RM-14	14	191	113	345
1RM-15	15	200	130	411
1RM-16	16	208	158	400
1RM-17	17	226	180	427
1RM-18	18	237	213	437
1RM-19	19	248	233	443
1RM-21	21	290	343	788
1RM-22	22	290	343	602
1RM-24	24	323	503	717
1RM-27	27	359	550	1.188
1RM-30	30	393	750	1.391
1RM-32	32	425	900	1.582

Sada kombinovaných ráčnových klíčů, metrických

1RM/SH6

8 10 12 13 14 17 mm



2.289 Kč

1RM/SH8

8 10 11 12 13 14 17 19 mm



3.208 Kč



1RM/SH12

8 9 10 11 12 13 14 15 16 17 18 19 mm



4.725 Kč

S4RM/3T

Sada oboustranných ráčnových klíčů, 4 v 1

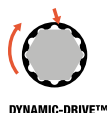

DYNAMIC-DRIVE™



12 ROZMĚRŮ VE 3 KLÍČÍCH

8x9x10x11 mm
12x13x14x15 mm
16x17x18x19 mm



3625PU- Kladivo bez zpětného rázu



BAHCO	mm	mm	g	Kč
3625PU-30	300	35	300	591
3625PU-50	340	50	640	756
3625PU-60	400	60	1080	980

S9HEX Sada hlavíc Imbus

- Vysoce výkonná legovaná ocel, matný povrch
- ISO 1174/DIN 3120

1/2" Šestihran

M 4 5 6 7 8 10 12 14 17



2484/S4 Sada páčidel

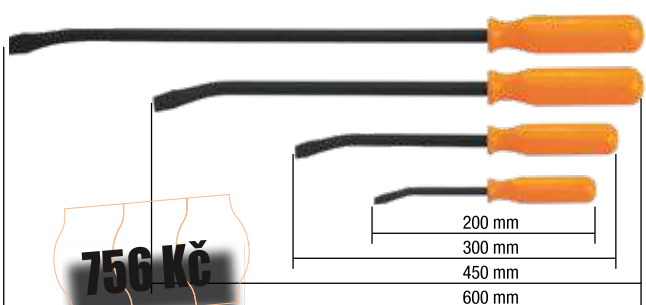

756 Kč

200 mm
300 mm
450 mm
600 mm



3,422 Kč

S530T Sada nástrčných klíčů s průchozí ráčnou

- Průchozí obousměrná ráčna pro dlouhé závity, 3/8" (19 mm), 72 zubů
- Metrické rozměry
- Vysoce výkonná legovaná ocel, matný povrch
- DIN 3120, ISO 1174



S přepínací páčkou

10 11 12 13 14 15 16 17 19 21 22 24
8 9 10 11 12 13 14 15 16 17
E8 E10 E11 E12 E14 E16 E18 E20 E22
3/8" 72 zubů
3/8" 75
3/8" 1/4" & 3/8" & 1/2"
3/8" 1/4" & 5/16"
5/16" M 7 8 10 12 mm
5/16" TTX 40H 45H 50H 55H
1/4" M 5 6 mm
1/4" TTX 20H 25H 27H 30H



BWSS12P3 Sada rázových hlavíc na kola

1/2"

- Plastové ochranné pouzdro



17 mm

19 mm

21 mm

85 mm

PNEUMATICKÉ NÁŘADÍ

Rázové utahováký



BAHCO	BAR	mm	U/min	Nm	Max Nm	min ⁻¹	dba	mm	kg	Kč	
BPC813	1/2"	6.3	10	113	407	678	10000	87	120	1.54	5.201
BPC815	1/2"	6.3	10	113	786	1112	8000	88	187	1.91	6.838
BPC817	3/4"	6.2	10	198	1627	2034	5000	96	220	3.44	13.529

Excentrická bruska

■ Obsahuje kotouč Velcro®



BAHCO	mm	mm	BAR	mm	U/min	W	min ⁻¹	dba	m/sec ²	mm	kg	Kč
BP601	152	5	6.3	10	255	224	11 000	80	< 2.50	195	0.8	5.025
BP610	152	2.5	6.3	10	255	224	11 000	80	< 2.50	195	0.8	5.025

Ofukovací pistole

Mosazná špička

BAHCO	BAR	mm	U/min	dba	mm	kg	Kč	
BP219	1/2"	6.3	10	68	<80	240	0.13	318
BP219L	1/2"	6.3	10	340	<80	470	0.15	339
BP219XL	1/2"	6.3	10	100	<80	1050	0.25	553



BLT550
Infračervený teploměr

- Jednoduché a bezkontaktní měření povrchové teploty motoru, chladicí kapaliny, klimatizace, výfukového systému, dílů motoru nebo topení atd.
- 9V baterie není součástí balení



± 1,5 %
0,1 °C
D:S 12:1
500 ms
8-14 μm

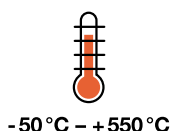

995 Kč

BP822
Přímá bruska 3 mm



3.181 Kč

mm	BAR	mm	W	mm	mm	mm	kg
3	6.3	10	170	201	25 000	85	4.52

782-U
Drátěný kartáč

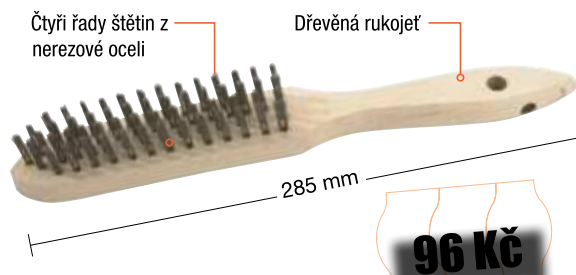

Čtyři řady štětín z nerezové oceli
Dřevěná rukojeť
285 mm
96 Kč

- K odstraňování nečistot, rzi, barev, laků atd.

Abrazivní vysoce výkonné řezné kotouče !!! balení 50 kusů ■ Certifikováno ve shodě OSA dle EN12413



3912-125-T41-IM 3911-125-T41-IM 3911-150-T41-I

BAHCO	Aplikace/Materiál	Ø mm	Ø mm	mm	Kvalita	BAL.	Kč
3912-125-T41-IM	Nerez a kov	125	22,23	1	4★	50	28 *
3911-125-T41-IM	Nerez a kov	125	22,23	1,6	5★	50	28 *
3911-150-T41-I	Nerez	150	22,23	1	5★	50	46 *

- Neobsahuje železo, síru ani chloridy

Lamelové kotouče

!!! balení 20 kusů

■ Certifikováno ve shodě OSA dle EN13743



3926-125IM-C60 3926-125IM-C80 3926-125IM-C120

BAHCO	Aplikace/Materiál	Ø mm	Ø mm	Kvalita	BAL.	Kč
3926-125IM-C60	Nerez a kov	125	22,23	5★	20	104 *
3926-125IM-C80	Nerez a kov	125	22,23	5★	20	104 *
3926-125IM-C120	Nerez a kov	125	22,23	5★	20	104 *

- Neobsahuje železo, síru ani chloridy

Lamelové kotouče

!!! balení 20 kusů

■ Certifikováno ve shodě OSA dle EN13743



3927-125IM-P60 3927-125IM-P80 3927-125IM-P120

BAHCO	Aplikace/Materiál	Ø mm	Ø mm	Kvalita	BAL.	Kč
3927-125IM-P60	Nerez a kov	125	22,23	4★	20	86 *
3927-125IM-P80	Nerez a kov	125	22,23	4★	20	86 *
3927-125IM-P120	Nerez a kov	125	22,23	4★	20	86 *

- Lehké, pružné a tiché díky vícevrstvému uložení brusných lamel
- Neobsahuje železo, síru ani chloridy

Vysoce výkonné řezné kotouče

!!! balení 25 kusů

■ Certifikováno ve shodě OSA dle EN12413



3921-125-T27-IM 3921-150-T27-IM

BAHCO	Aplikace/Materiál	Ø mm	Ø mm	mm	Kvalita	BAL.	Kč
3921-125-T27-IM	Nerez a kov	125	22,23	6.4	5★	25	52 *
3921-150-T27-IM	Nerez a kov	150	22,23	6.4	5★	25	76 *

- Neobsahuje železo, síru ani chloridy

Dodávky pouze na počty ks v balení

* cena za 1 ks

MOMENTOVÉ NÁŘADÍ

74WR-

Mechanický momentový klíč, nastavitelný

- Robustní mechanismus - po více než 100 000 cyklech v toleranci $\pm 3\%$
- Pevná ráčnová hlava
- Přesnost měření $\pm 3\%$, dle normy ISO 6789-1:2017

Snadno čitelná dvojitá stupnice

Zvukový a hmatový signalizační systém při kliknutí



Ozánčení středu rukojeti pro optimální uchopení



Odolný vůči:
benzín, olej,
hydraulické kapaliny



Intervaly opakování kalibrace



BAHCO	Nm	mm	mm	g	Kč
74WR-15	3–15	1/4"	221	300	
74WR-25	5–25	1/4"	221	300	

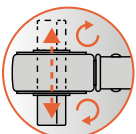

- Průchozí čtyřhran na změnu směru otáčení



Pohodlný na dotek příjemný povrch

BAHCO	Nm	ft.lb	mm	mm	g	Kč
74WR-50	10–50	7.5–37.5	3/8"	335	700	4.725
74WR-100	20–100	15–75	1/2"	387	900	
74WR-200	40–200	30–150	1/2"	470	1100	
74WR-300	60–300	45–220	1/2"	593	1400	5.201
74WR-340	60–340	45–250	1/2"	685	1500	
74WR-400	80–400	60–300	3/4"	686	1900	6.986



Odolný vůči:
benzín, olej,
hydraulické kapaliny

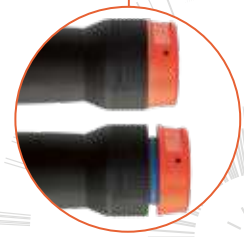

Tlačítko pro nastavení utahovacího momentu, zřetelně viditelné při uvolnění

7455-

Mechanický momentový klíč, s pevnou obousměrnou ráčnovou hlavou a kovovou rukojetí

- Přesnost utahovacího momentu ± 4%
- Dodává se s certifikátem dle normy DIN EN ISO 6789
- Vyrobený v USA



Klikací systém vydává hmatový a zvukový signál po dosažení točivého momentu



Robustní, celokovový odolný klíč



Neklouzavá, vroubkovaná kovová rukojeť, odolná vůči nárazům a všem běžným chemikáliím



BAHCO	Nm	ft.lb	□	←mm→	g	Kč
7455-100	20– 100	16.6– 71.9	3/8"	400	1.135	4.457
7455-200	40– 200	37– 140	1/2"	474	1.430	4.906
7455-340	60– 340	52– 243	1/2"	613	1.680	5.798
7455-500	100– 500	83– 359.6	3/4"	870	4.370	12.341
7455-800	150– 800	129– 572	3/4"	1047	5.310	16.797
7455-1000	200– 1000	184– 701	1"	1055	6.350	25.420



BAHCO	Nm	ft.lb	□	←mm→	g	Kč
7455-1500	300– 1500	258– 1069	1"	1780	11.395	37.016



TSS600

Nastavitelný momentový šroubovák se stupnicí v Nm a in.lb.

- Měření momentu je možné pouze při utahování ve směru hodinových ručiček
- Přesnost ± 6% při utahování ve směru hodinových ručiček
- Testováno podle DIN EN ISO 6789



Ochrana proti přetočení spojku zabraňuje překročení nastavené hodnoty točivého momentu při utahování doprava



BAHCO	Nm	□	←mm→	g	Kč
TSS600	1-6	1/4"	195	340	4.013



NABÍJEČKY AUTOBATERÍ

BBCE612-2

2 A plnoautomatická nabíječka/dobíječka akumulátorů s napájecím režimem, 8 fází nabíjení



BBCE12-3

3 A plnoautomatická nabíječka/dobíječka akumulátorů s napájecím režimem, 8 fází nabíjení



BBCE12-6

6 A plnoautomatická nabíječka/dobíječka akumulátorů s napájecím režimem, 8 fází nabíjení



BBCE12-10

10 A plnoautomatická nabíječka/dobíječka akumulátorů s napájecím režimem, 8 fází nabíjení



BBJL 3545 Startovací kabely

■ Plně izolované kabely i svorky



- průřez kabelu 35 mm²
- délka kabelů 4,5 m



AUTO-ELEKTRO KAROSERIE

BMMTRMS1

Digitální multimetr s výstupem do PC

- Vhodný pro měření napětí AC/DC, proudu, frekvence, odporu, kapacity, průchodnosti nebo polaritu nebo teploty

3.416 Kč

12 jazyků
+ PC software



1 x
9V
včetně



Silikonový
testovací kabel



Kabel sondy T°



Specifikace:

- True RMS měření skutečné efektivní hodnoty
- Bezkontaktní měření napětí
- Relativní měření
- Automatické vypínání
- Zálohování dat
- Podsvícený displej
- Auto/uživatelský manuál
- Polaritu indikace
- Test diod
- Test kontinuity
- Indikace slabé baterie
- DC rozsah napětí : 600mV ±0,5%, 6V/60V/600V ±0,8%, 1000V ±1,0%
- AC rozsah napětí: 600mV/6V/600V ±1,0%, 1000V ±1,5%
- DC proud: 600uA/6mA/60mA/600mA/10A ±1,5%
- Kategorie měření: CATIII 1,000V CATIV 600V
- Odpor: 600Ω/6KΩ/60KΩ/600KΩ/6MΩ ±0,5%, 60MΩ ±1,5%
- Kapacita: 6nF ±3,0%, 600nF/6uF/60uF/300uF ±5,0%
- Logická frekvence: 10Hz~1MHz ±(0,1%+3)
- Lineární frekvence: 10Hz~10KHz ±(0,05%+8)
- Pracovní cyklus: 1%~99%
- Teplota: -55°C~1000°C ±(2%+2)
- Pojistka: 0,63A/1000Vx1 pro rozsahy uA a mA & 10A/1000Vx1 pro rozsah 10A

BH8PR10000

Pěchovací sada 10 t

- Pro lisování, upínání a roztahování částí karoserie
- Včetně hydraulického ručního čerpadla a tlakového válce 10 t, prodlužovacích trubek, přítlačné desky a různých přídatných zařízení

19



10 t

8.234 Kč

SVÍTIDLA / INSPEKČNÍ NÁŘADÍ

BLTS10

Tenká kapesní svítilna



10 SMD LED 180 Lumen 4 h IP20 USB 2100 mAh-s Li-ion

1.232 Kč

BLTS7P

Tužková kapesní svítilna



7 SMD LED 45 Lumen 4 h IP20 USB

805 Kč

BFRL11

Čelovka

- 2 režimy osvětlení: potkávací (20%), dálkové (100%)
- Optická čočka

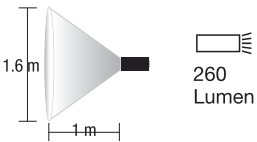

1.538 Kč

5515T

Ohebné teleskopické zrcátko

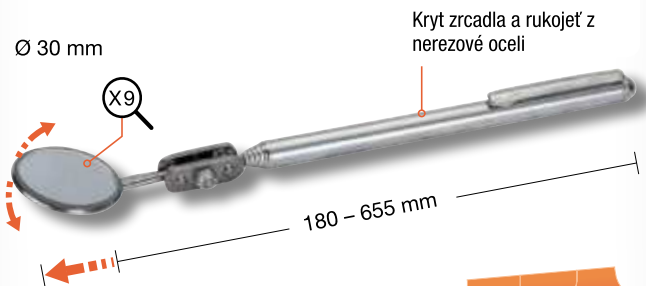

411 Kč

5515T-52

Ohebné teleskopické zrcátko

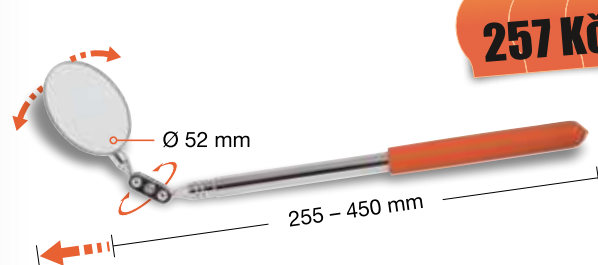

257 Kč

BLTFC1

Flexibilní svítilno s hliníkovým rámem

- Indikátor nabíjení



1 SMD LED 180 Lumen IP20 2000 mAh-s Li-ion

2.5 h

USB

1.872 Kč

5515B

Servisní zrcátko

- Vhodné pro práci na deskách elektrických obvodů

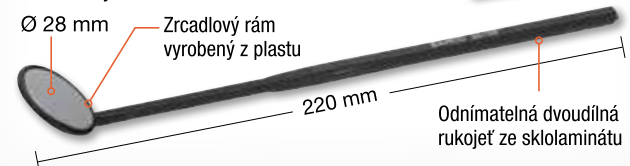

246 Kč

Odnímatelná dvoudílná rukojeť ze sklolaminátu

ŠROUBOVÁKY

Šroubováky ERGO™ pro šrouby s vnitřním šestihranem

ergo®

- Kulový tvar špičky pro lepší přístup



balení 5 kusů

BAHCO				Kč
BE-8715	● H 1.5 x 60	20 x 122	182	132
BE-8702	● H 2 x 100	20 x 122	222	131
BE-8725	● H 2.5 x 100	20 x 122	222	135
BE-8703	● H 3 x 100	20 x 122	222	139
BE-8704	● H 4 x 100	27 x 122	222	161
BE-8705	● H 5 x 100	36 x 122	222	198
BE-8706	● H 6 x 125	36 x 122	247	229
BE-8708	● H 8 x 150	36 x 122	272	337

Šroubováky ERGO™ pro šrouby s rovnou drážkou

ergo®

- BE-8160 se šestihranem pro použití vidlicového klíče na zvýšení točivého momentu



balení 5 kusů

BAHCO					Kč
BE-8010	⊖ 0.4 x 2.5 x 60	20 x 122	182	-	96
BE-8030	⊖ 0.6 x 3.5 x 75	20 x 122	197	-	116
BE-8040	⊖ 0.8 x 4.0 x 100	20 x 122	222	-	135
BE-8150	⊖ 1 x 5.5 x 100	27 x 122	222	-	178
BE-8155	⊖ 1.2 x 6.5 x 125	36 x 122	247	-	212
BE-8160	⊖ 1.6 x 8 x 125	36 x 122	247	14	347

Šroubováky ERGO™ pro šrouby s drážkou Torx

ergo®



balení 5 kusů

BAHCO				Kč
BE-8904	⊕ T 4 x 75	20 x 122	197	149
BE-8905	⊕ T 5 x 75	20 x 122	197	149
BE-8906	⊕ T 6 x 75	20 x 122	197	149
BE-8907	⊕ T 7 x 75	20 x 122	197	149
BE-8908	⊕ T 8 x 75	20 x 122	197	151
BE-8909	⊕ T 9 x 75	20 x 122	197	151
BE-8910	⊕ T 10 x 75	20 x 122	197	116
BE-8915	⊕ T 15 x 100	27 x 122	222	158
BE-8920	⊕ T 20 x 100	27 x 122	222	192
BE-8925	⊕ T 25 x 125	27 x 122	247	205
BE-8930	⊕ T 30 x 150	36 x 122	272	206

Šroubováky ERGO™ pro šrouby s drážkou Phillips®

ergo®

- BE-8630 se šestihranem pro použití vidlicového klíče na zvýšení točivého momentu



balení 5 kusů

BAHCO					Kč
BE-8600	⊕ PH 0 x 60	20 x 122	182	-	128
BE-8610	⊕ PH 1 x 75	27 x 122	197	-	162
BE-8620	⊕ PH 2 x 100	36 x 122	222	-	221
BE-8630	⊕ PH 3 x 150	36 x 122	272	14	499

Šroubováky ERGO™ pro šrouby s drážkou Pozidriv®

ergo®

- BE-8830 se šestihranem pro použití vidlicového klíče na zvýšení točivého momentu



balení 5 kusů

BAHCO					Kč
BE-8800	⊕ PZ 0 x 60	20 x 122	182	-	158
BE-8810	⊕ PZ 1 x 75	27 x 122	197	-	183
BE-8820	⊕ PZ 2 x 100	36 x 122	222	-	241
BE-8830	⊕ PZ 3 x 150	36 x 122	272	14	360



ŠROUBOVÁKY

BE-9881SL

Sada šroubováků ERGO™
s úzkou čepelí, izolovaných

ergo®  1000 V 

■ Podle IEC 900, DIN EN 60900,
VDE 0682 část 201

ÚZKÁ ČEPEL



● 30% užší
než běžné čepel



5

 0.5x3.0 mm 1.0x5.5 mm
0.8x4.0 mm

 PH1
PH2

BE-9881i

Sada šroubováků ERGO™ z nerezové oceli

ergo® 

DŘÍK Z NEREZOVÉ OCELI CHRÁNÍ PŘED TVORBOU RZI

■ ISO 2380 / DIN 5264



6

 0.5x3.0 mm 1.0x5.5 mm
0.8x4.0 mm 1.2x6.5 mm

 PH1
PH2

783 Kč

BE-9881TB

Sada šroubováků ERGO™
s průchozí čepelí

6



ergo®



0.6x3.5x75
0.8x4.5x100
1.0x5.5x100
1.2x6.5x125



PH1 x100
PH2 x125



BE-9770i

Sada zahnutých
imbusových klíčů
z nerezové oceli

9



■ Čepel z nerezové oceli na
ochranu před kontaminací
cizími částicemi

■ S kuličkou pro lepší přístup



● 1.5 2 2.5 3 4 5 6 8 10 mm



487 Kč

BE-9877

Sada XXL šroubováků ERGO™

■ Ergonomická 3-složková rukojeť



!!! balení 5 kusů

1.243 Kč

NOVÉ



0.6x3.5x75 mm
1.0x5.5x100 mm



PH1 x75 mm
PH2 x100 mm



PZ1 x75 mm
PZ2 x100 mm



T10x75 mm
T15x100 mm
T20x100 mm
T25x125 mm

**Izolované 1000 V
šroubováky**

Podle IEC 900,
DIN EN 60900,
VDE 0682 část 201



0.5x3.0x100 mm
0.8x4.0x100 mm
1.0x5.5x125 mm



PH1 x80 mm
PH2 x100 mm

BE-9876S

Sada XXL izolovaných šroubováků ERGO™



Kombinovaná drážka
Křížová drážka PZ1 5 mm
Křížová drážka PZ2 6 mm



PZ1
PZ2



PH1
PH2



T10
T15
T20



0.4x2.5 mm 0.8x4.0 mm
0.5x3.0 mm 1.0x5.5 mm
0.6x3.5 mm

■ Vyrobeno podle normy IEC 900, DIN EN 60900, VDE 0682 část 201

■ Ergonomická 3-složková rukojeť

1.259 Kč

BITY A RÁČNOVÉ ŠROUBOVÁKY

59/S54BC Sada bitů

● 1/4" DIN 3126-C6.3, ISO 1173

54



<25mm>							<125mm>	<150mm>
4.5	PH1	PZ1	T10 x2	TR10	HEX3	R1	PH1	T20
5.5	PH2 x4	PZ2 x4	T15 x2	TR15	HEX4	R2	PH2	T25
	PH3	PZ3	T20 x4	TR20	HEX5			T30
	PH2G x2		T25 x2	TR25	HEX6		+	
			T27	TR30	HEX8			
			T30 x4					
			T40					

BAREVNÉ

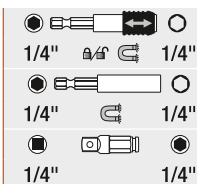

59/S100BC Sada bitů

● 1/4" DIN 3126-C6.3, ISO 1173

100



<25mm>						
4.5	PH1	PZ1 x2	T10 x3	TR10	HEX3	R1
5.5	PH2 x9	PZ2 x9	T15 x5	TR15	HEX4 x3	R2
	PH3	PZ3	T20 x15	TR20	HEX5	
	PH2G x5		T25 x8	TR25	HEX6 x3	
			T27	TR30	HEX8	
			T30 x15			
			T40 x3			

BAREVNÉ

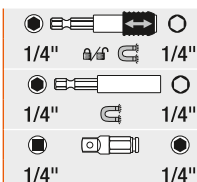

59/S31B Sada bitů

31

balení 12 kusů



4.5	PH1	PZ1	T10	HEX3
5.5	PH2 x3	PZ2 x3	T15 x3	HEX4
	PH3	PZ3	T20 x3	HEX5
	PH2G x2		T25 x2	HEX6
			T27	
			T30	

● 1/4" DIN 3126-C6.3, ISO 1173





808050P

Ráčnový šroubovák, držák bitů s pistolovou rukojetí

● 1/4" DIN 3126-C6.3, ISO 1173

- Stisknutím tlačítka se rukojeť otočí a zablokuje v poloze 30°
- Se 6 bitů v zásobníku v rukojetí

⊖	⊕	⊕
0.6x4.5	PH1	PZ1
0.8x5.5	PH2	PZ2



30°

808050S

Ráčnový šroubovák, držák bitů, krátký

● 1/4" DIN 3126-C6.3, ISO 1173

- Pro práci ve stísněných prostorech



454 Kč

808050L

Ráčnový šroubovák, držák bitů s LED osvětlením

● 1/4" DIN 3126-C6.3, ISO 1173

- Se 6 bitů v zásobníku v rukojetí

⊖	⊕	⊕
0.6x4.5	PH1	PZ1
0.8x5.5	PH2	PZ2



652 Kč

KM653-QR-1P

Magnetický držák bitů

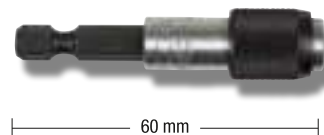

181 Kč

○	●
1/4"	1/4"



808061

Sada izolovaných dřívků s ráčnovou rukojetí



2.491 Kč

808061



⊖	0.4x2.5	0.5x3.0	0.8x4.0	1.0x5.5
⊕	PH1	PH2		

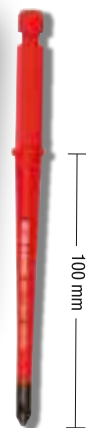

2058/S26

Sada bitů, nástrčných klíčů, ráčnového klíče a adaptérů



- Díky patentovanému 1/4" ráčnovému klíči (US Pat. 6860175) se dají šrouby a matice lehce uvolnit a utáhnout i ve stísněných prostorech

8 mm						1/4"					
⊖	⊕	⊕	⊕	●	○	⊖	⊕	⊕	⊕	●	○
4.0	PH1	PZ1	T10	3	6						
5.0	PH2	PZ2	T15	4	7						
6.0	PH3	PZ3	T20	5	8						
			T25	6	10						
			T30		13						
●	○	○	○	○	○	○	○	○	○	○	○
1/4"	1/4"	1/4"	1/4"	1/4"	1/4"	1/4"	1/4"	1/4"	1/4"	1/4"	1/4"



Obousměrné ráčny s úzkou hlavou

Tlačítko pro rychlé uvolnění



Páčka pro rychlou změnu směru



6950SL

Obousměrná ráčna 1/4"

■ 72 zubů

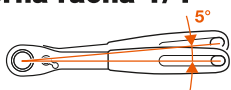

7750SL

Obousměrná ráčna 3/8"

■ 72 zubů

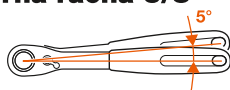

8150SL

Obousměrná ráčna 1/2"

■ 72 zubů

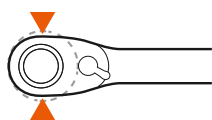
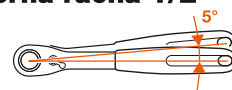

Velmi úzká hlava pro práci v úzkých stísněných prostorech



BAHCO	□	△	← mm →	g	Kč
6950SL	1/4"	5°	120	90	801
7750SL	3/8"	5°	205	200	995
8150SL	1/2"	5°	265	440	1.135

KM6750

Nástrčný klíč s magnetem



BAHCO	●	○	Kč
KM6750-8	1/4"	8 mm	96
KM6750-10	1/4"	10 mm	96

D/S14

Sada rázových nástrčných klíčů



■ 1/2"

- Vysoce výkonná legovaná ocel, černé
- DIN 3129, ISO 2725

DYNAMIC-DRIVE™



1.517 Kč

○ 10 11 12 13 14 15 16 17 18 19	← mm → 38
○ 20 21 22	
○ 24 27	← mm → 45

SADY NÁSTRČNÝCH KLÍČŮ



SL25
Sada nástrčných klíčů **25**

- 1/4"
- Metrické rozměry
- Vysoce výkonná legovaná ocel, matný povrch
- ISO 1174/DIN 3120



DYNAMIC-DRIVE™

Bahco
Online-
Katalog >



○ 4 4.5 5 5.5 6 7 8 9 10 11 12 13
● 1/4" 60 zubů, úhel záběru 6°
● 1/4" 100 mm
○ 1/4" 1/4"
⊕ T10 15 20 25 30 40
● M 5 6 ⊕ PH 1 2

S140T
Sada nástrčných klíčů s průchozí ráčnou **14**



- Vysoce výkonná legovaná ocel, matný povrch
- ISO 1174/DIN 3120

○ 10 11 12 13 14 15 16 17 19 21 22 24
● 3/8" 72 zubů
● 3/8" 3/8" <mm> 75



1.276 Kč

SL25L
Sada nástrčných klíčů **37**

- 1/4"
- Metrické rozměry
- S prodlouženými nástrčnými klíči
- Vysoce výkonná legovaná ocel, matný povrch
- ISO 1174/DIN 3120



DYNAMIC-DRIVE™

Bahco
Online-
Katalog >



○ 4 4.5 5 5.5 6 7 8 9 10 11 12 13
○ 4 5 6 7 8 9 10 11 12 13
● 1/4" 60 zubů, úhel záběru 6°
● 1/4" 100 mm
○ 1/4" 1/4"
⊕ T10 15 20 25 30 40
● M 4 5 6
⊕ PH2 x 2 ⊕ PZ2 x 2



1.637 Kč

S330
Sada nástrčných klíčů **34**

- 1/4" + 3/8"
- Metrické rozměry
- Vysoce výkonná legovaná ocel, matný povrch
- ISO 1174/DIN 3120



DYNAMIC-DRIVE™

Bahco
Online-
Katalog >



○ 10 11 12 13 14 15 16 17 18 19 20 22
○ 16 21
● 3/8" 60 zubů, úhel záběru 6°
● 3/8" 75 & 150 mm
● 3/8"
○ 3/8" 1/4"
● 1/4" 1/4"
● 1/4"
⊖ 4 5.5 7
⊕ PH 1 2 3 4
● M 3 4 5 6 7 8





S240
Sada nástrčných klíčů 

1/2"

- Metrické rozměry
- Vysoce výkonná legovaná ocel, matný povrch
- ISO 1174/DIN 3120



DYNAMIC-DRIVE™

Bahco
Online-
Katalog >



10 11 12 13 14 15 16 17 18 19 20 21 22 23
24 27 30 32

1/2" 60 zubů, úhel záběru 6°

1/2" 250 mm

1/2" 125 & 150 mm

1/2" &



2.732 Kč

41RM/SH8

Sada kombinovaných ráčnových klíčů, s výkyvnou hlavou 



DYNAMIC-DRIVE™

- Vysoce výkonná legovaná ocel, matný povrch
- ISO 1174/DIN 3120



8 10 11 12 13 14 17 19 mm



2.458 Kč

S330L
Sada nástrčných klíčů 

1/4" + 3/8"

- Metrické rozměry
- ISO 1174/DIN 3120
- S prodlouženými nástrčnými klíči
- Vysoce výkonná legovaná ocel, matný povrch



DYNAMIC-DRIVE™

Bahco
Online-
Katalog >



10 11 12 13 14 15 16 17 18 19 20 22

10 11 12 13 14 15 17 18 19 20 22

16 21

3/8" 60 zubů, úhel záběru 6°

3/8" 75 & 150 mm

3/8" &

3/8" 1/4"

1/4" 1/4"

1/4" &

1/4" &

4 5.5 7

PH 1 2 3 PZ 1 2

M 2.5 3 4 5 6 7 8

T10 T15 T20 T25 T30 T40



3.061 Kč



Obousměrná ráčna
s úzkou hlavou a 72 zubyn

S560
Sada nástrčných klíčů 

1/4" + 1/2"

- Metrické rozměry
- ISO 1174/DIN 3120
- S 12-hrannými nástrčnými klíči
- Vysoce výkonná legovaná ocel, matný povrch



DYNAMIC-DRIVE™

Bahco
Online-
Katalog >



4 4.5 5 5.5 6 7 8 9 10 11 12 13

1/4" 4 5 6 7 8 9 10 11 12 13

1/4" 72 zubů, úhel záběru 5°

1/4" &

1/4" 50 & 100 mm

1/4" &

10 11 12 13 14 15 17 19 22 24 27

1/2" 30 32

1/2" 16 21

1/2" 72 zubů, úhel záběru 5°

1/2" 250 mm

1/2" 125 & 150 mm

1/2" &

1/2" 5/16"

1/4" 1/4"

1/4" 1/4"

1/4" 1/4"

5/16" T45 T50 T55

1.5 2 2.5

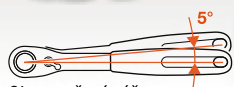

Obousměrná ráčna s úzkou hlavou a 72 zubůn

4.845 Kč

S95

Sada nástrčných klíčů



1/4" + 1/2"

- Metrické rozměry
- Vysoce výkonná legovaná ocel, matný povrch
- ISO 1174/DIN 3120

NOVÉ



Bahco Online-Katalog >



1/4"	4 4.5 5.5 6 7 8 9 10 11 12 13
1/4"	72 zubů, úhel záběru 5°
1/4"	
1/4"	75 & 150 mm
1/4"	
1/2"	10 11 12 13 14 15 17 18 19 20 21 22 24 27 30 32
1/2"	16 21
1/2"	7 zubů, úhel záběru 5°
1/2"	125 & 150 mm
1/2"	
1/2"	1.5 2 2.5 3 4 5 6 8 10
	7, 8, 9, 10, 11, 12, 13, 14, 15, 16, 17, 18, 19
1/4"	1/4" 1/4" 1/4" 1/4"
	4.5 5.5
	PH1 PH2 PH2 PH2 PH2 PH3 PH2G PH2G
	PZ1 PZ2 PZ2 PZ2 PZ3
	T10 T15 T15 T15 T20 T20 T20 T25 T25 T27 T30
	M 3 4 5 6



S106

Sada nástrčných klíčů



1/4" + 1/2"

- Metrické + Palcové rozměry
- Vysoce výkonná legovaná ocel, matný povrch
- ISO 1174/DIN 3120



Bahco Online-Katalog >



1/4"	4 4.5 5.5 6 7 8 9 10 11 12 13
1/4"	4 5 6 7 8 9 10 11 12 13
1/4"	60 zubů, úhel záběru 6°
1/4"	
1/4"	75 & 150 mm
1/4"	
1/2"	10 11 12 13 14 15 17 19 20 22 24 27 30 32
1/2"	3/8" 7/16" 1/2" 9/16" 11/16" 3/4" 13/16" 7/8" 1/2" 1.3/16"
1/2"	16 21
1/2"	17 19 21 24
1/2"	60 zubů, úhel záběru 6°
1/2"	250 mm
1/2"	125 & 150 mm
1/2"	
1/4"	1/4"
1/4"	1/4"
	4 5.5 7
	PH 1 2 3 4
	M 3 4 5 6 7 8
	1.5 2 2.5
	8 9 10 11 12 13 14 15 17 19 21 24 27
	8-9 10-11 12-13 14-15



7.966 Kč

SLX 17

Sada nástrčných klíčů



3/4"

- Metrické rozměry
- Vysoce výkonná legovaná ocel, matný povrch
- ISO 1174/DIN 3120



Bahco Online-Katalog >



3/4"	22 24 27 30 32 33 34 36 38 41 46 50
3/4"	
3/4"	500 - 815 mm
3/4"	200
3/4"	400
3/4"	



- Kufr z vysoce odolného polyetylénu HDPE; odolný vůči nárazům, olejům a teplotám

NASTAVITELNÉ KLÍČE

9031 C

Nastavitelné klíče ERGO™



ergo®

- ISO 6787, DIN 3117, ASME B107.8M-2003 a BS 6333



Pohodlná a protiskuzová rukojeť z termoplastického materiálu

- Pochromované, přesně kalené s protikorozní úpravou

BAHCO	 mm	 mm	 mm	 g	Kč
9031 C	38	6	218	340	788

9031-T





Nastavitelné klíče ERGO™ se štíhlými čelistmi

ergo®

Pohodlná a protiskuzová rukojeť z termoplastického materiálu



- Fosfátováno, přesně kaleno s protikorozní úpravou

BAHCO	 mm	 mm	 mm	 g	Kč
9031-T	38	4.5	218	325	1.013





80

Klasické nastavitelné klíče



- ISO 6787, DIN 3117, ASME B107.8M-2003 a BS 6333

- přesně kalené s protikorozní úpravou

BAHCO	 mm	 mm	 mm	 g	Kč
8074	44	14	380	1035	1.752
8075	53	17.7	455	1665	2.705

ADJUST 3



Sada nastavitelných klíčů

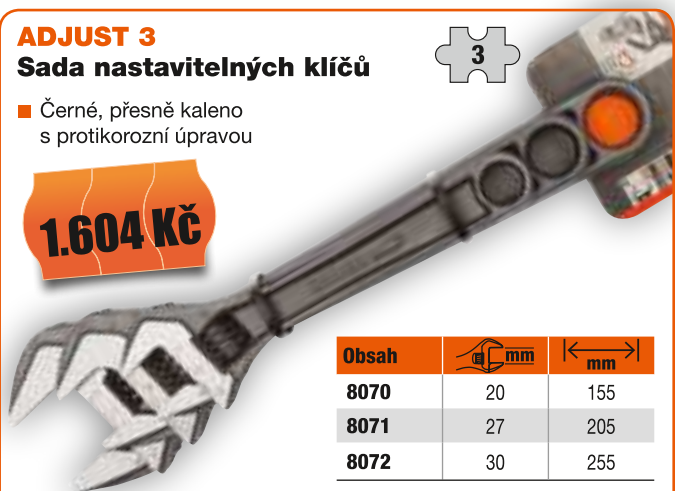

- Černé, přesně kaleno s protikorozní úpravou

1.604 Kč



Obsah	 mm	 mm
8070	20	155
8071	27	205
8072	30	255

BOČNÍ ŠTÍPACÍ KLEŠTĚ

2101G Boční štípací kleště ERGO™ pro elektrikáře

■ ISO 5749

ergo®



Progresivní řezné hrany:
Štípání tvrdých materiálů
těsně u kloubu a měkkých
materiálů u špičky



Ergonomická dvousložková
rukojeť pro optimální uchopení



Úzký tvar
hlavy

Mini-ramínka pro
lepší držení

Indukčně kalené
řezné hrany

Šroubení poskytuje vynikající chod
a přesné nastavení řezných hran

BAHCO	mm	Fe+ mm		Kč
	125	2.2	černé	641
	140	2.5	černé	652
	160	2.7	černé	668
	180	2.7	černé	712

BAHCO	mm	Fe+ mm		Kč
2101GC-160IP	160	2.7	pochromované	745

MA325 Převodové nůžky na plech

ergo®



1.139 Kč

mm	Fe+ mm
250	1,2

1520 G Pákové štípací kleště



63-64 Hrc



Pohodlná dvousložková
rukojeť

Vysoký pákový převod pro
vysoký výkon při vyvinutí
minimální námahy

Centrické přesné hrany na štípání
strunového, tvrdého a měkkého drátu

mm	Fe+ mm
208	3.8



2101PG-160 Boční štípací kleště ERGO™

ergo®

■ ISO 5749

speciálně na plasty



Indukčně kalené
řezné hrany

Rukojeť ERGO™ z
dvousložkového materiálu

mm	CU	PA (Nylon)
160	1.5 mm	3.0 mm

1.161 Kč

KLEŠTĚ ERGO™

2628 G- Kombinované kleště ERGO™

■ ISO 5746

ergo®

Ergonomická dvousložková rukojeť pro optimální uchopení

Indukčně kalené
řezné hrany



2628 G
černé

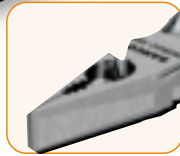

2628 GC-
pochromované

BAHCO	mm	mm*		Kč
2628 GC-180IP	180	2.5	pochromované	750
2628 GC-200IP	200	3.0	pochromované	903
2628 G-160	160	2.0	černé	
2628 G-180	180	2.5	černé	
2628 G-200	200	3.0	černé	

*Piano drát

2430 G- Kleště se špičatými plochými čelistmi ERGO™

■ ISO 5745

Štíhlé, půlkulaté a
vroubkované čelisti



Dlouhé špičky pro lepší přístup
ve stísněných prostorech

BAHCO	mm	CU mm	Fe mm	Fe+ mm	Kč
2430 G-160	160	3.0*	1.8*	1.6*	690

316-2 Výstružník ve tvaru pera



- Plastový kryt s extra HSS čepelí uvnitř
- Náhradní čepel je dostupná: 316-2-95

487 Kč

72- Kleště s posuvným kloubem

■ ISO 8976

Pohodlná dvousložková rukojeť



Štíhlé čelisti pro lepší přístup
ve stísněných prostorech



25 nastavitel-
ných poloh

BAHCO	mm	mm	Kč
7223	49	200	
7224	61	250	
7225	71	300	1.090

9897 Sada kleští ERGO™

2101G-160
Boční štípací kleště



2.732 Kč

1410/1420 Trubkové klíče ERGO™

■ DIN 5234

■ Štíhlé čelisti pro lepší přístup
ve stísněných prostorech

Pohodlná dvousložková
rukojeť



Patentované progresivní ozubení
s indukčně kalenými čelistmi pro
lepší uchopení trubek

BAHCO	mm	mm	mm	Kč
1410	45	1" - 38 mm	320	1.232
1420	65	1 1/2" - 57 mm	430	1.577

PILY NA KOV

319 balení 3 kusy Ruční rámová pila na kov

- Lehký rám s ocelovým jádrem



Upínací mechanismus v rukojeti

Sandflex® Bimetal
 <mm> 300 T⁷ 24

320 balení 5 kusů Ruční rámová pila na kov

290 Kč

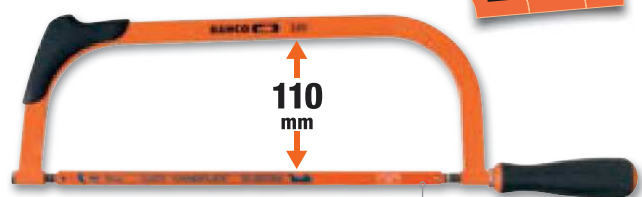

- Výška rámu 110 mm
- Možnost upnutí listu pod 90 ° úhlem

Sandflex® Bimetal
 <mm> 300 T⁷ 24

3906 Pilové listy SANDFLEX® Bimetal

!!! balení 100 kusů

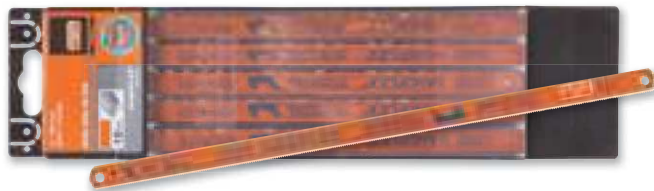

BAHCO			mm	Kč
3906-300-18-100	100	18	300 x 13 x 0,65	39*
3906-300-24-100	100	24	300 x 13 x 0,65	39*
3906-300-24-10P	10	24	300 x 13 x 0,65	405 balení 5 kusů

* Cena za kus

- Nezlomitelný, pružný bimetalový pilový list
- 20% rychlejší řezný výkon, 35% delší životnost

208 balení 5 kusů Mini rámová pilka na kov 250 mm



Sandflex® Bimetal
 <mm> 250 T⁷ 24



3834-upsize Adaptér na upevnění vodící vykrúžovací pily

!!! balení 2kusy

73 Kč

- Umožňuje upevnit menší vykrúžovací pilu jako vodící při vrtání velkého průměru

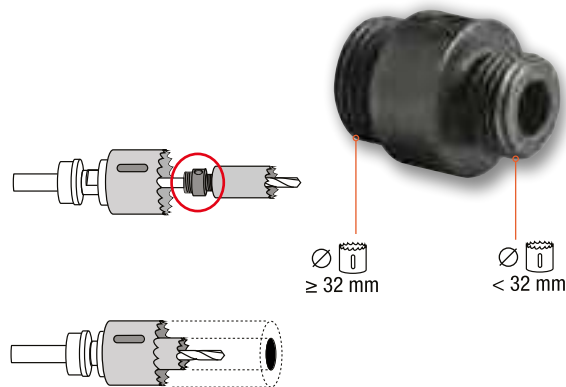

BRAŠNY NA NÁŘADÍ

4750FB3-12

12" brašna na nářadí pro elektrikáře, prázdná



Dodáváno bez nářadí

Skrytá plastová schránka ve spodní části

1.664 Kč

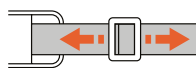

■ S vyztuženým plastovým dnem

285 x 285 x 190 mm

4750FB4-18

18" brašna pro laptop i nářadí, prázdná

- Polstrovaná přihrádka pro laptop
- S vyztuženým plastovým dnem

2.524 Kč



Dodáváno bez nářadí

350 x 430 x 150 mm

4750-VMPH-1

Pouzdro na mobilní telefon

- Na suchý zips, hodí se na jakýkoliv opasek

400 Kč



Organizér na nářadí, prázdný

Dodáváno bez nářadí



246 Kč

4750FB5A Malý

275 x 170 x 55 mm

Dodáváno bez nářadí

427 Kč

4750FB5B Střední

330 x 270 x 70 mm

Dodáváno bez nářadí

4750FB5C Velký

526 Kč

400 x 300 x 90 mm

- Měkká pogumovaná rukojeť
- Sítovaná kapsa na dokumenty

4750FB1-19B

19" uzavíratelná brašna na nářadí s krytem, prázdná

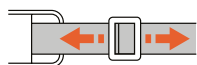

1.855 Kč

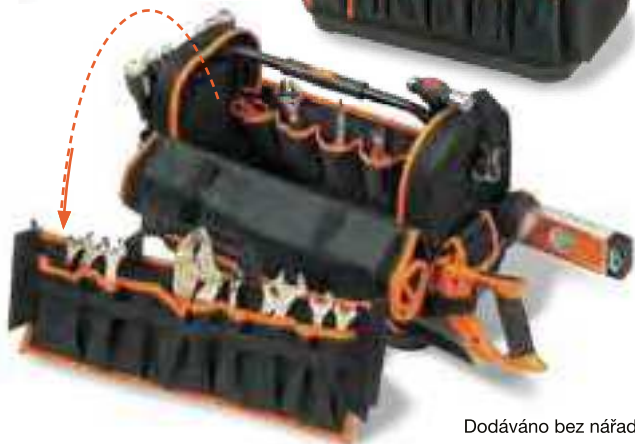

Dodáváno bez nářadí

- S vyztuženým plastovým dnem
- Polstrovaný ramenní popruh a rukojeť

 470 x 230 x 355 mm

4750FB1-19A

19" Otevřená brašna na nářadí s plastovým dnem, prázdná

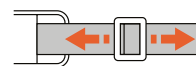

Dodáváno bez nářadí

- Vodotěsné plastové dno

 470 x 230 x 355 mm

4750PTB60

Přenosný plastový box na nářadí, prázdný

- Mimořádně odolný a vhodný pro použití v extrémních podmínkách

 600 x 305 x 295 mm

Dlouhá hliníková rukojeť

Dva zvenku vyjímatelné boxy



1.161 Kč

3100TB

Otevřená brašna na nářadí, prázdná

- Vodotěsné dno
- Pohodný polstrovaný ramenní popruh a rukojeť

1.161 Kč

 400 x 600 x 400 mm



TMR s.r.o.

lepidla - tmely - spreje - nářadí

provozovna:

Mniší 160, 742 21 Kopřivnice

mobil: 602 725 634

e-mail: info@spreje.cz

www.spreje.cz